

General Description

SFGMOS[®] MOSFET is based on Oriental Semiconductor's unique device design to achieve low $R_{DS(ON)}$, low gate charge, fast switching and excellent avalanche characteristics. The low V_{th} series is specially designed to use in synchronous rectification power systems with low driving voltage.

Features

- Low $R_{DS(ON)}$ & FOM
- Extremely low switching loss
- Excellent reliability and uniformity
- Fast switching and soft recovery



Applications

- PD charger
- Motor driver
- Switching voltage regulator
- DC-DC convertor
- Switched mode power supply

Key Performance Parameters

| Parameter | Value | Unit |
|-------------------------------|-------|------------|
| $V_{DS, min} @ T_{j(max)}$ | 100 | V |
| $I_{D, pulse}$ | 210 | A |
| $R_{DS(ON) max} @ V_{GS}=10V$ | 10 | m Ω |
| Q_g | 49.9 | nC |

Marking Information

| Product Name | Package | Marking |
|--------------|---------|-----------|
| SFG10R10PF | TO220 | SFG10R10P |

Package & Pin information

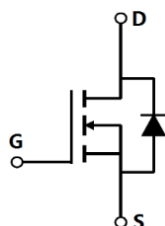

Absolute Maximum Ratings at $T_j=25^{\circ}\text{C}$ unless otherwise noted

| Parameter | Symbol | Value | Unit |
|---|----------------|------------|--------------------|
| Drain source voltage | V_{DS} | 100 | V |
| Gate source voltage | V_{GS} | ± 20 | V |
| Continuous drain current ¹⁾ , $T_C=25^{\circ}\text{C}$ | I_D | 70 | A |
| Pulsed drain current ²⁾ , $T_C=25^{\circ}\text{C}$ | $I_{D, pulse}$ | 210 | A |
| Continuous diode forward current ¹⁾ , $T_C=25^{\circ}\text{C}$ | I_S | 70 | A |
| Diode pulsed current ²⁾ , $T_C=25^{\circ}\text{C}$ | $I_{S, Pulse}$ | 210 | A |
| Power dissipation ³⁾ , $T_C=25^{\circ}\text{C}$ | P_D | 125 | W |
| Single pulsed avalanche energy ⁵⁾ | E_{AS} | 100 | mJ |
| Operation and storage temperature | T_{stg}, T_j | -55 to 150 | $^{\circ}\text{C}$ |

Thermal Characteristics

| Parameter | Symbol | Value | Unit |
|--|-----------------|-------|----------------------|
| Thermal resistance, junction-case | $R_{\theta JC}$ | 1 | $^{\circ}\text{C/W}$ |
| Thermal resistance, junction-ambient ⁴⁾ | $R_{\theta JA}$ | 62 | $^{\circ}\text{C/W}$ |

Electrical Characteristics at $T_j=25^{\circ}\text{C}$ unless otherwise specified

| Parameter | Symbol | Min. | Typ. | Max. | Unit | Test condition |
|----------------------------------|--------------|------|------|------|------------------|---|
| Drain-source breakdown voltage | BV_{DSS} | 100 | | | V | $V_{GS}=0\text{ V}, I_D=250\ \mu\text{A}$ |
| Gate threshold voltage | $V_{GS(th)}$ | 1.0 | | 2.5 | V | $V_{DS}=V_{GS}, I_D=250\ \mu\text{A}$ |
| Drain-source on-state resistance | $R_{DS(ON)}$ | | 8.5 | 10.0 | $\text{m}\Omega$ | $V_{GS}=10\text{ V}, I_D=10\text{ A}$ |
| Drain-source on-state resistance | $R_{DS(ON)}$ | | 9.5 | 12.0 | $\text{m}\Omega$ | $V_{GS}=4.5\text{ V}, I_D=10\text{ A}$ |
| Gate-source leakage current | I_{GSS} | | | 100 | nA | $V_{GS}=20\text{ V}$ |
| | | | | -100 | | $V_{GS}=-20\text{ V}$ |
| Drain-source leakage current | I_{DSS} | | | 1 | μA | $V_{DS}=100\text{ V}, V_{GS}=0\text{ V}$ |
| Gate resistance | R_G | | 4.5 | | Ω | $f=1\text{ MHz}, \text{Open drain}$ |

Dynamic Characteristics

| Parameter | Symbol | Min. | Typ. | Max. | Unit | Test condition |
|------------------------------|--------------|------|------|------|------|--|
| Input capacitance | C_{iss} | | 2604 | | pF | $V_{GS}=0\text{ V}$, $V_{DS}=50\text{ V}$, $f=1\text{ MHz}$ |
| Output capacitance | C_{oss} | | 361 | | pF | |
| Reverse transfer capacitance | C_{rss} | | 6.5 | | pF | |
| Turn-on delay time | $t_{d(on)}$ | | 20.6 | | ns | $V_{GS}=10\text{ V}$, $V_{DS}=50\text{ V}$, $R_G=2.2\ \Omega$, $I_D=25\text{ A}$ |
| Rise time | t_r | | 5 | | ns | |
| Turn-off delay time | $t_{d(off)}$ | | 51.8 | | ns | |
| Fall time | t_f | | 9 | | ns | |

Gate Charge Characteristics

| Parameter | Symbol | Min. | Typ. | Max. | Unit | Test condition |
|----------------------|---------------|------|------|------|------|---|
| Total gate charge | Q_g | | 49.9 | | nC | $V_{GS}=10\text{ V}$, $V_{DS}=50\text{ V}$, $I_D=25\text{ A}$ |
| Gate-source charge | Q_{gs} | | 6.5 | | nC | |
| Gate-drain charge | Q_{gd} | | 12.4 | | nC | |
| Gate plateau voltage | $V_{plateau}$ | | 3.4 | | V | |

Body Diode Characteristics

| Parameter | Symbol | Min. | Typ. | Max. | Unit | Test condition |
|-------------------------------|-----------|------|-------|------|------|--|
| Diode forward voltage | V_{SD} | | | 1.3 | V | $I_S=12\text{ A}$, $V_{GS}=0\text{ V}$ |
| Reverse recovery time | t_{rr} | | 60.4 | | ns | $V_R=50\text{ V}$, $I_S=12\text{ A}$, $di/dt=100\text{ A}/\mu\text{s}$ |
| Reverse recovery charge | Q_{rr} | | 106.1 | | nC | |
| Peak reverse recovery current | I_{rrm} | | 3 | | A | |

Note

- 1) Calculated continuous current based on maximum allowable junction temperature.
- 2) Repetitive rating; pulse width limited by max. junction temperature.
- 3) P_d is based on max. junction temperature, using junction-case thermal resistance.
- 4) The value of $R_{\theta JA}$ is measured with the device mounted on 1 in 2 FR-4 board with 2oz. Copper, in a still air environment with $T_a=25\text{ }^\circ\text{C}$.
- 5) $V_{DD}=50\text{ V}$, $V_{GS}=10\text{ V}$, $L=0.3\text{ mH}$, starting $T_j=25\text{ }^\circ\text{C}$.

Electrical Characteristics Diagrams

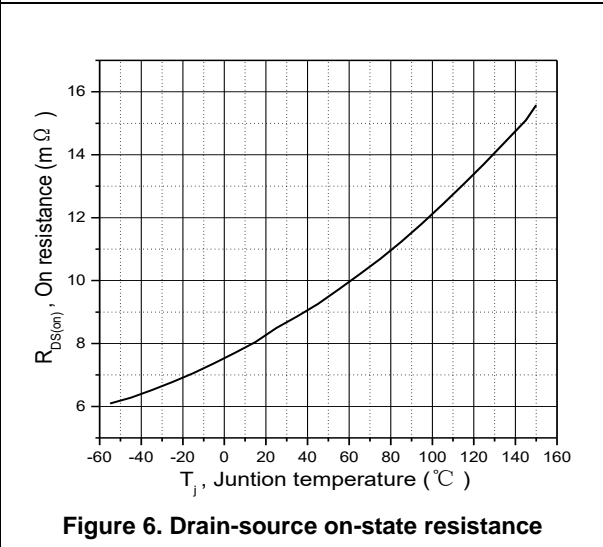
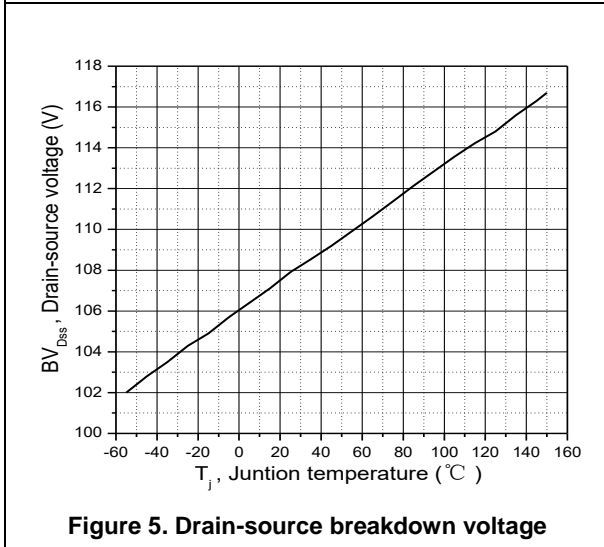
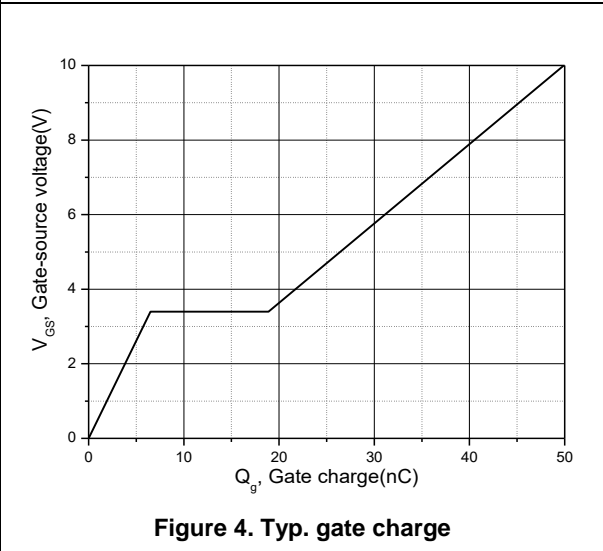
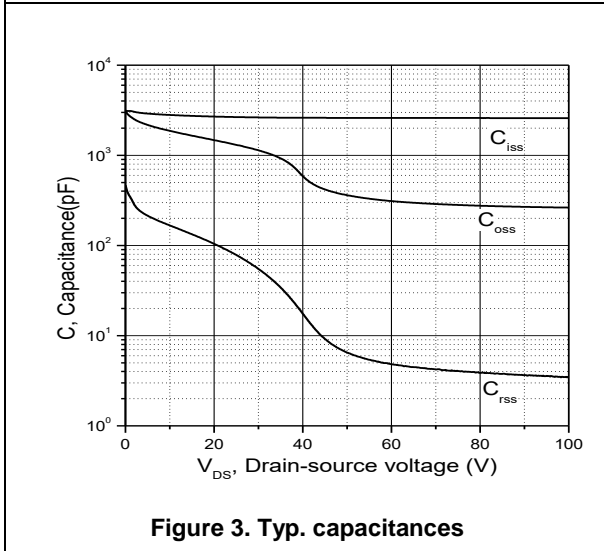
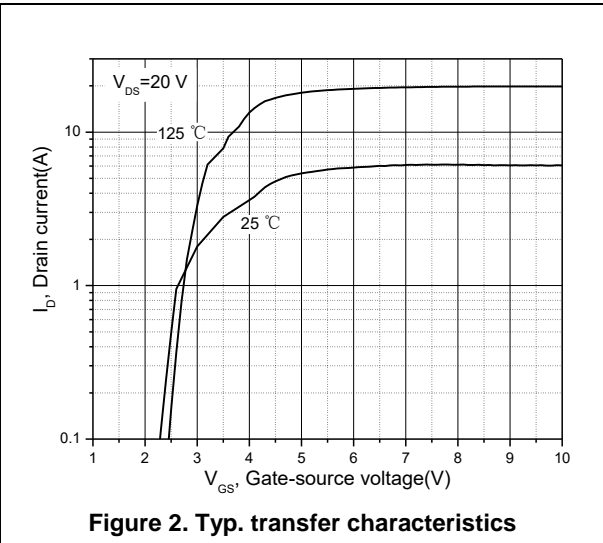
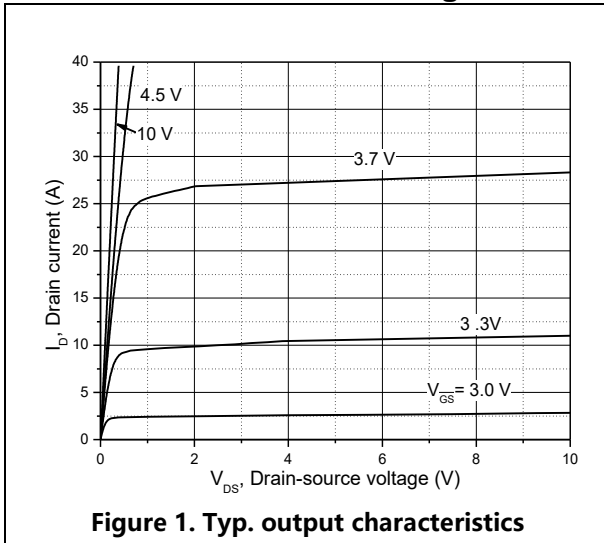

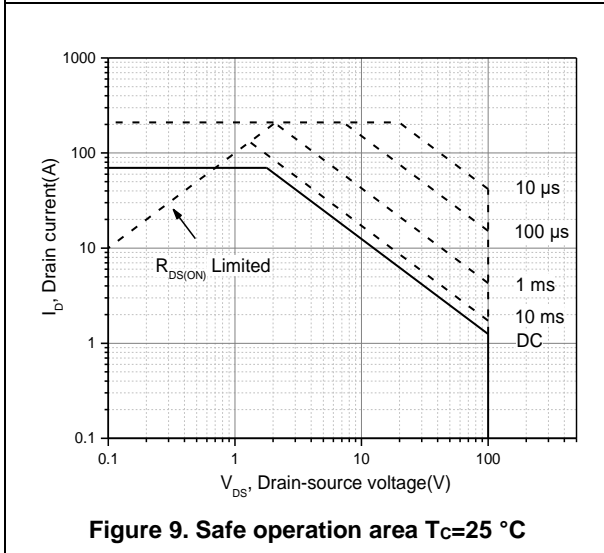
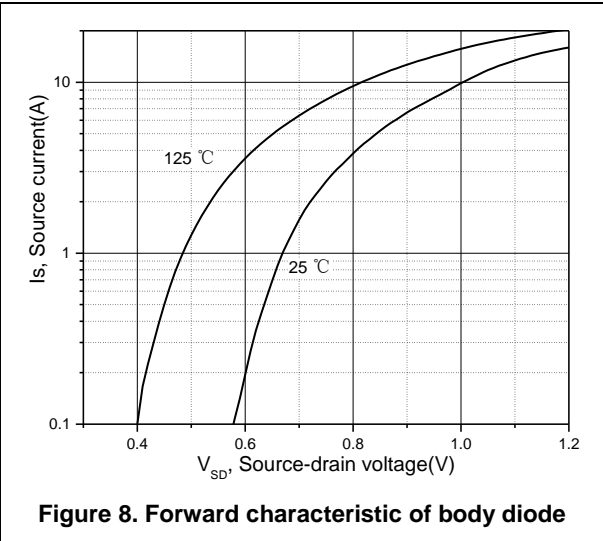
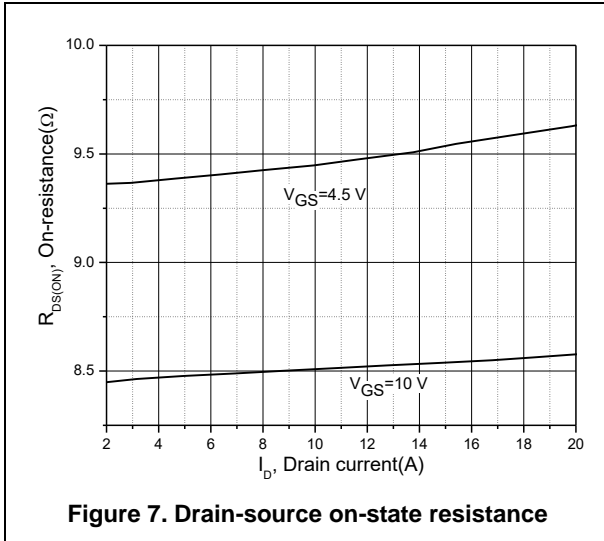

Test circuits and waveforms

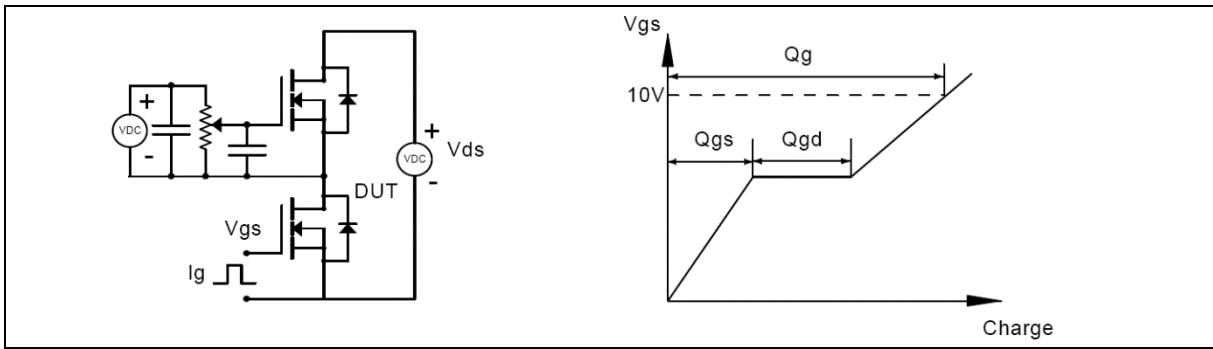

Figure 1. Gate charge test circuit & waveform



Figure 2. Switching time test circuit & waveforms

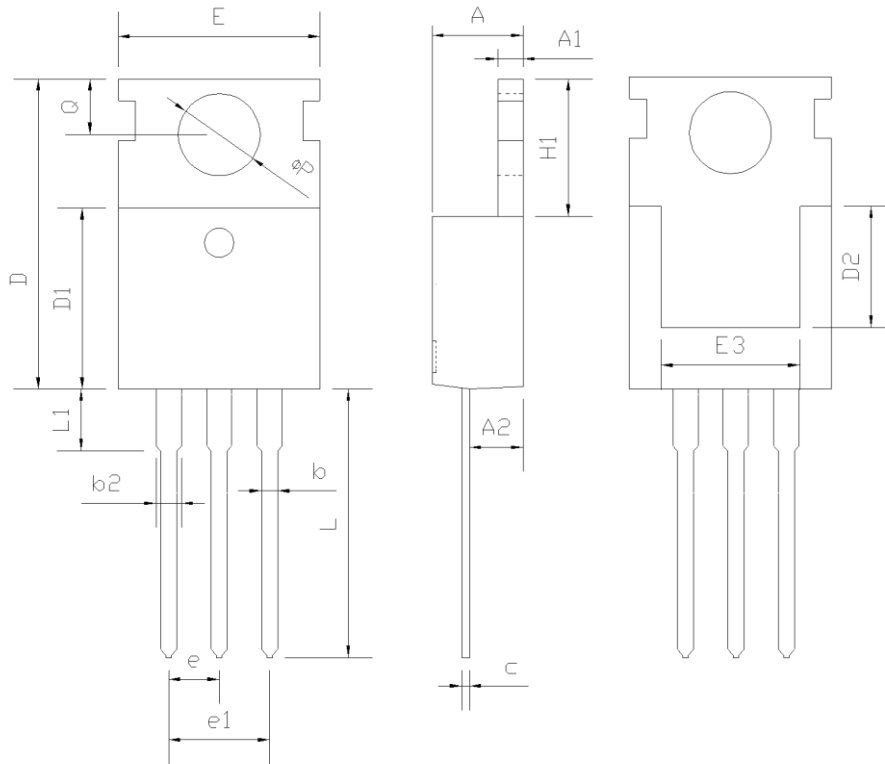

Figure 3. Unclamped inductive switching (UIS) test circuit & waveforms



Figure 4. Diode reverse recovery test circuit & waveforms

Package Information



| Symbol | mm | | |
|--------|----------|-------|-------|
| | Min | Nom | Max |
| A | 4.37 | 4.57 | 4.77 |
| A1 | 1.25 | 1.30 | 1.45 |
| A2 | 2.20 | 2.40 | 2.60 |
| b | 0.70 | 0.80 | 0.95 |
| b2 | 1.17 | 1.27 | 1.47 |
| c | 0.40 | 0.50 | 0.65 |
| D | 15.10 | 15.60 | 16.10 |
| D1 | 8.80 | 9.10 | 9.40 |
| D2 | 5.50 | - | - |
| E | 9.70 | 10.00 | 10.30 |
| E3 | 7.00 | - | - |
| e | 2.54 BSC | | |
| e1 | 5.08 BSC | | |
| H1 | 6.25 | 6.50 | 6.85 |
| L | 12.75 | 13.50 | 13.80 |
| L1 | - | 3.10 | 3.40 |
| ΦP | 3.40 | 3.60 | 3.80 |
| Q | 2.60 | 2.80 | 3.00 |

Version 1: TO220-C package outline dimension

Package Information

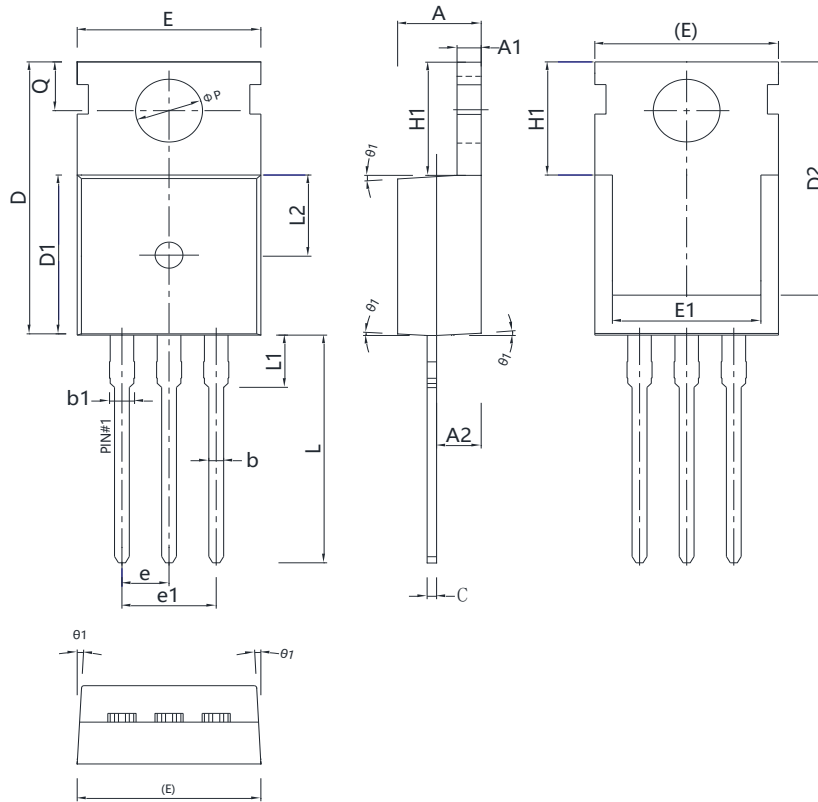

| Symbol | mm | | |
|--------|----------|-------|-------|
| | Min | Nom | Max |
| A | 4.40 | 4.50 | 4.60 |
| A1 | 1.27 | 1.30 | 1.33 |
| A2 | 2.30 | 2.40 | 2.50 |
| b | 0.70 | - | 0.90 |
| b1 | 1.27 | - | 1.40 |
| c | 0.45 | 0.50 | 0.60 |
| D | 15.30 | 15.70 | 16.10 |
| D1 | 9.10 | 9.20 | 9.30 |
| D2 | 13.10 | - | 13.70 |
| E | 9.70 | 9.90 | 10.20 |
| E1 | 7.80 | 8.00 | 8.20 |
| e | 2.54 BSC | | |
| e1 | 5.08 BSC | | |
| H1 | 6.30 | 6.50 | 6.70 |
| L | 12.78 | 13.08 | 13.38 |
| L1 | - | - | 3.50 |
| L2 | 4.60 REF | | |
| ΦP | 3.55 | 3.60 | 3.65 |
| Q | 2.73 | - | 2.87 |
| θ1 | 1° | 3° | 5° |

Version 2: TO220-J package outline dimension

Ordering Information

| Package Type | Units/ Tube | Tubes / Inner Box | Units/ Inner Box | Inner Boxes/ Carton Box | Units/ Carton Box |
|--------------|-------------|-------------------|------------------|-------------------------|-------------------|
| TO220-C | 50 | 20 | 1000 | 6 | 6000 |
| TO220-J | 50 | 20 | 1000 | 5 | 5000 |

Product Information

| Product | Package | Pb Free | RoHS | Halogen Free |
|------------|---------|---------|------|--------------|
| SFG10R10PF | TO220 | yes | yes | yes |

Legal Disclaimer

The information given in this document shall in no event be regarded as a guarantee of conditions or characteristics. With respect to any examples or hints given herein, any typical values stated herein and/or any information regarding the application of the device, Oriental Semiconductor hereby disclaims any and all warranties and liabilities of any kind, including without limitation, warranties of non-infringement of intellectual property rights of any third party.

For further information on technology, delivery terms and conditions and prices, please contact the Oriental Semiconductor sales representatives (www.orientalsemi.com).

© Oriental Semiconductor Co.,Ltd. All Rights Reserved /