

### General Description

FSMOS<sup>®</sup> MOSFET is based on Oriental Semiconductor's unique device design to achieve low  $R_{DS(ON)}$ , low gate charge, fast switching and excellent avalanche characteristics. The low  $V_{th}$  series is specially optimized for synchronous rectification systems with low driving voltage.

### Features

- Low  $R_{DS(ON)}$  & FOM
- Extremely low switching loss
- Excellent reliability and uniformity
- Fast switching and soft recovery



### Applications

- PD charger
- Motor driver
- Switching voltage regulator
- DC-DC convertor
- Switched mode power supply

### Key Performance Parameters

Parameter	Value	Unit
$V_{DS, min} @ T_{j(max)}$	60	V
$I_D, pulse$	204	A
$R_{DS(ON), max} @ V_{GS}=10V$	10	m $\Omega$
$Q_g$	17.9	nC

### Marking Information

Product Name	Package	Marking
SFS06R10NF	PDFN3.3*3.3	SFS06R10N

### Package & Pin information

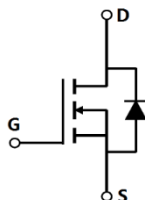

**Absolute Maximum Ratings** at  $T_j=25^\circ\text{C}$  unless otherwise noted

Parameter	Symbol	Value	Unit
Drain-source voltage	$V_{DS}$	60	V
Gate-source voltage	$V_{GS}$	$\pm 20$	V
Continuous drain current <sup>1)</sup> , $T_C=25^\circ\text{C}$	$I_D$	68	A
Pulsed drain current <sup>2)</sup> , $T_C=25^\circ\text{C}$	$I_{D, pulse}$	204	A
Continuous diode forward current <sup>1)</sup> , $T_C=25^\circ\text{C}$	$I_S$	68	A
Diode pulsed current <sup>2)</sup> , $T_C=25^\circ\text{C}$	$I_{S, pulse}$	204	A
Power dissipation <sup>3)</sup> , $T_C=25^\circ\text{C}$	$P_D$	81	W
Single pulsed avalanche energy <sup>5)</sup>	$E_{AS}$	91	mJ
Operation and storage temperature	$T_{stg}, T_j$	-55 to 150	$^\circ\text{C}$

**Thermal Characteristics**

Parameter	Symbol	Value	Unit
Thermal resistance, junction-case	$R_{\theta JC}$	1.54	$^\circ\text{C/W}$
Thermal resistance, junction-ambient <sup>4)</sup>	$R_{\theta JA}$	62	$^\circ\text{C/W}$

**Electrical Characteristics** at  $T_j=25^\circ\text{C}$  unless otherwise specified

Parameter	Symbol	Min.	Typ.	Max.	Unit	Test condition
Drain-source breakdown voltage	$BV_{DSS}$	60			V	$V_{GS}=0\text{ V}, I_D=250\ \mu\text{A}$
Gate threshold voltage	$V_{GS(th)}$	1.0		2.5	V	$V_{DS}=V_{GS}, I_D=250\ \mu\text{A}$
Drain-source on-state resistance	$R_{DS(ON)}$		7.5	10	m $\Omega$	$V_{GS}=10\text{ V}, I_D=20\text{ A}$
Drain-source on-state resistance	$R_{DS(ON)}$		10	14	m $\Omega$	$V_{GS}=4.5\text{ V}, I_D=10\text{ A}$
Gate-source leakage current	$I_{GSS}$			100	nA	$V_{GS}=20\text{ V}$
				-100		$V_{GS}=-20\text{ V}$
Drain-source leakage current	$I_{DSS}$			1	$\mu\text{A}$	$V_{DS}=60\text{ V}, V_{GS}=0\text{ V}$

### Dynamic Characteristics

Parameter	Symbol	Min.	Typ.	Max.	Unit	Test condition
Input capacitance	$C_{iss}$		1204		pF	$V_{GS}=0\text{ V}$ , $V_{DS}=50\text{ V}$ , $f=100\text{ kHz}$
Output capacitance	$C_{oss}$		194		pF	
Reverse transfer capacitance	$C_{rss}$		9.9		pF	
Turn-on delay time	$t_{d(on)}$		23.9		ns	$V_{GS}=10\text{ V}$ , $V_{DS}=50\text{ V}$ , $R_G=2\ \Omega$ , $I_D=25\text{ A}$
Rise time	$t_r$		4.6		ns	
Turn-off delay time	$t_{d(off)}$		37.8		ns	
Fall time	$t_f$		6.4		ns	

### Gate Charge Characteristics

Parameter	Symbol	Min.	Typ.	Max.	Unit	Test condition
Total gate charge	$Q_g$		17.9		nC	$V_{GS}=10\text{ V}$ , $V_{DS}=50\text{ V}$ , $I_D=25\text{ A}$
Gate-source charge	$Q_{gs}$		3.8		nC	
Gate-drain charge	$Q_{gd}$		4.2		nC	
Gate plateau voltage	$V_{plateau}$		4.2		V	

### Body Diode Characteristics

Parameter	Symbol	Min.	Typ.	Max.	Unit	Test condition
Diode forward voltage	$V_{SD}$			1.3	V	$I_S=20\text{ A}$ , $V_{GS}=0\text{ V}$
Reverse recovery time	$t_{rr}$		42.6		ns	$V_R=50\text{ V}$ , $I_S=25\text{ A}$ , $di/dt=100\text{ A}/\mu\text{s}$
Reverse recovery charge	$Q_{rr}$		36.3		nC	
Peak reverse recovery current	$I_{rrm}$		1.4		A	

### Note

- 1) Calculated continuous current based on maximum allowable junction temperature.
- 2) Repetitive rating; pulse width limited by max. junction temperature.
- 3)  $P_d$  is based on max. junction temperature, using junction-case thermal resistance.
- 4) The value of  $R_{\theta JA}$  is measured with the device mounted on 1 in 2 FR-4 board with 2oz. Copper, in a still air environment with  $T_a=25\text{ }^\circ\text{C}$ .
- 5)  $V_{DD}=30\text{ V}$ ,  $V_{GS}=10\text{ V}$ ,  $L=0.3\text{ mH}$ , starting  $T_j=25\text{ }^\circ\text{C}$ .

**Electrical Characteristics Diagrams**

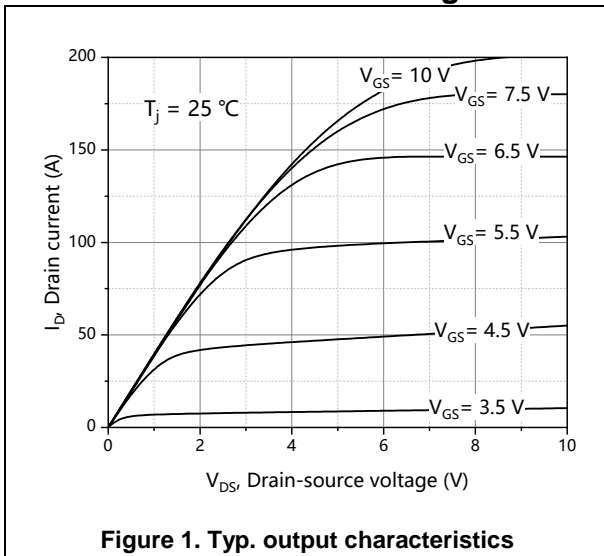

**Figure 1. Typ. output characteristics**

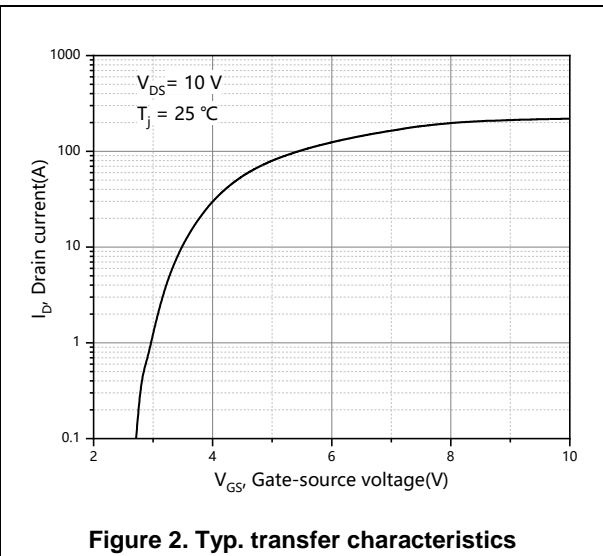

**Figure 2. Typ. transfer characteristics**

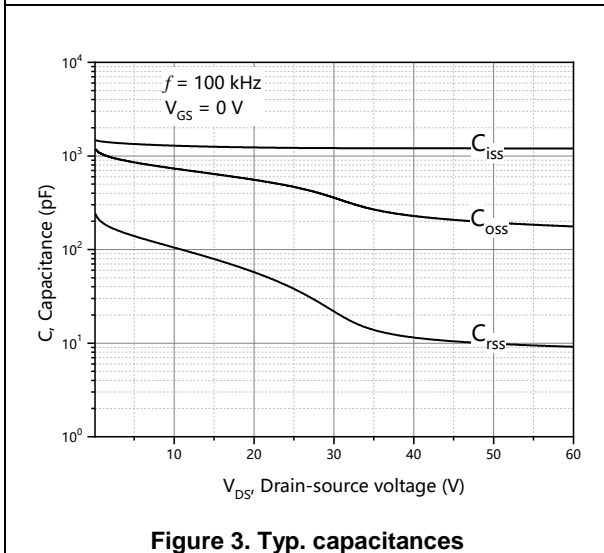

**Figure 3. Typ. capacitances**

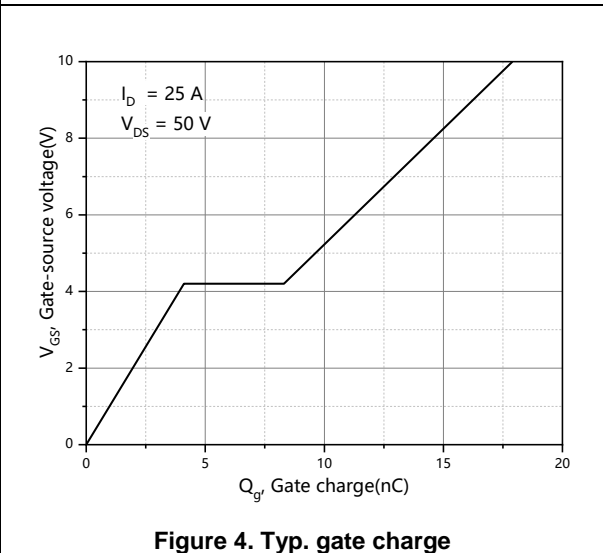

**Figure 4. Typ. gate charge**

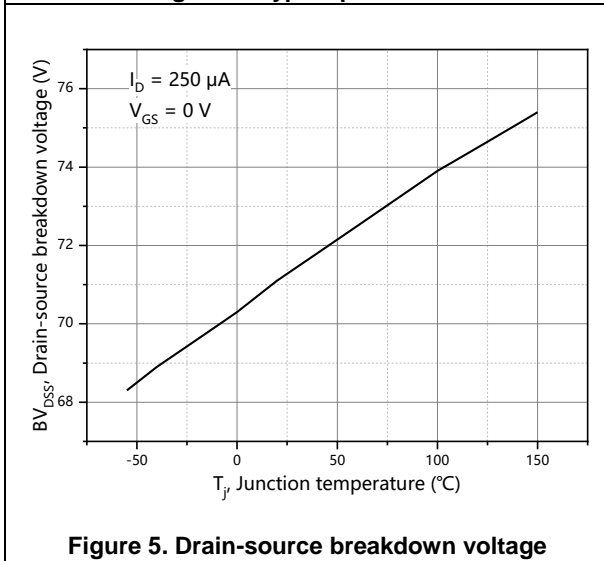

**Figure 5. Drain-source breakdown voltage**

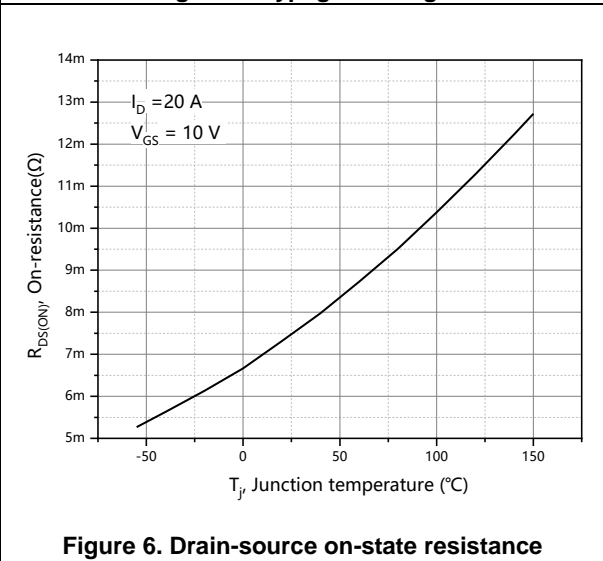

**Figure 6. Drain-source on-state resistance**

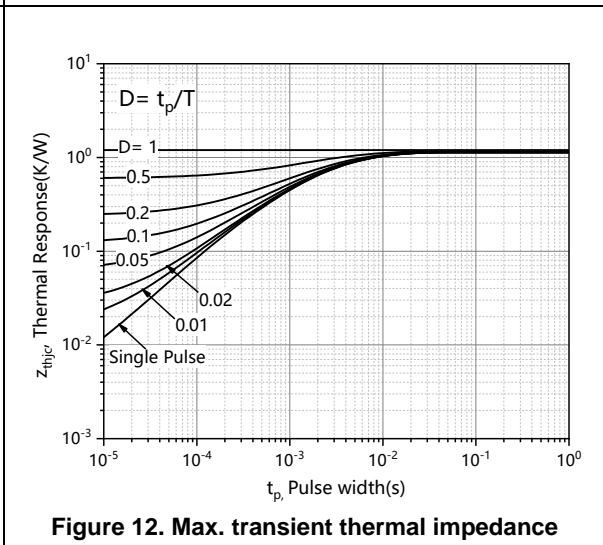
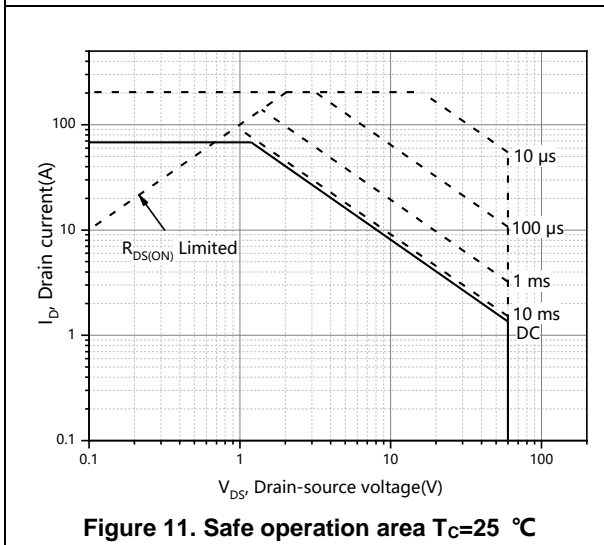
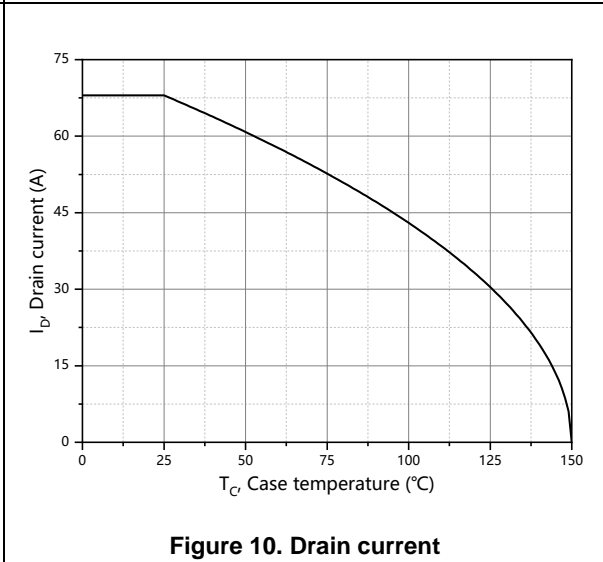
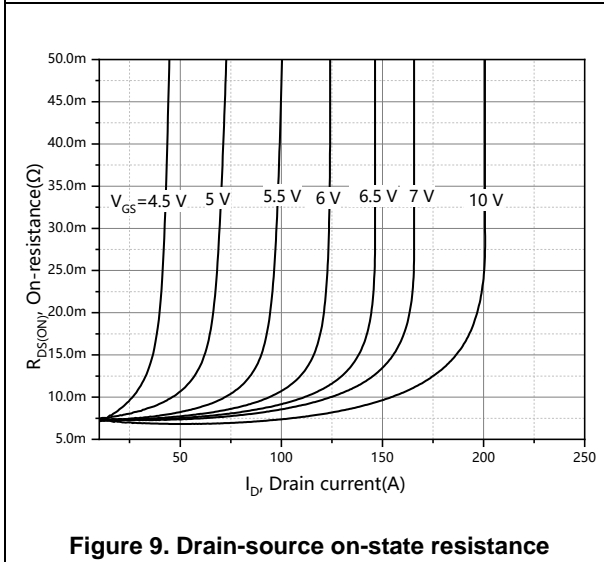
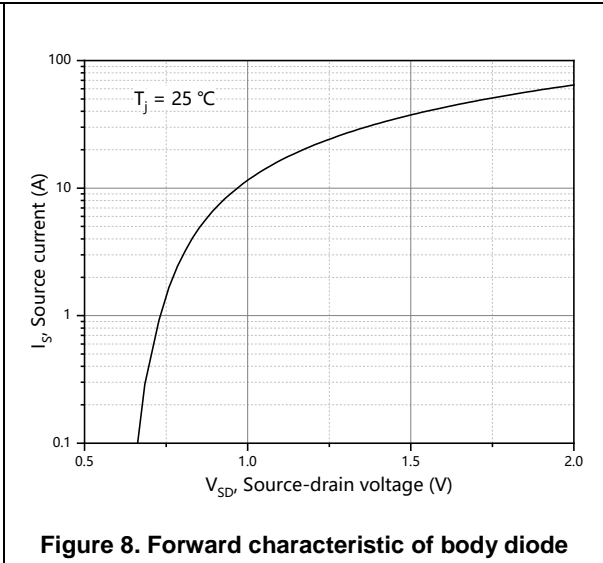
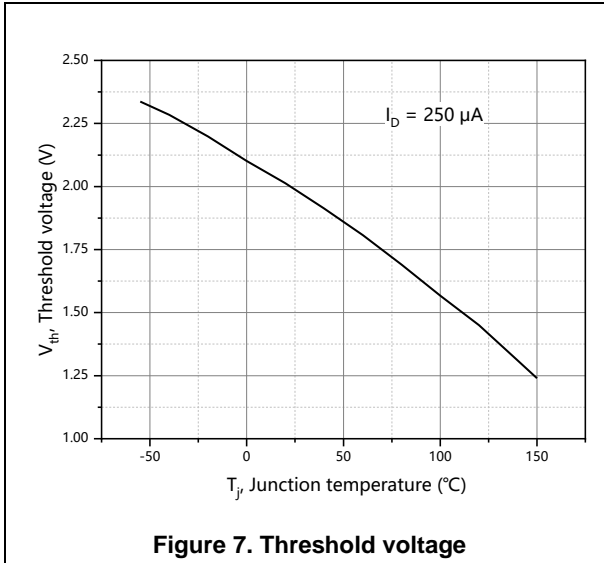

**Test circuits and waveforms**



**Figure 1. Gate charge test circuit & waveform**



**Figure 2. Switching time test circuit & waveforms**

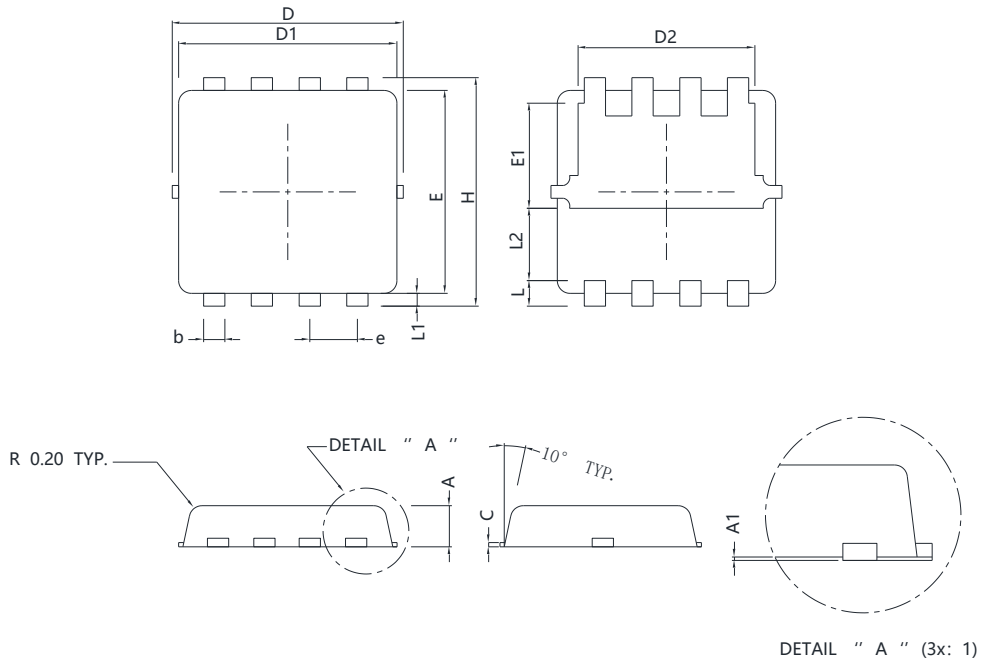

**Figure 3. Unclamped inductive switching (UIS) test circuit & waveforms**



**Figure 4. Diode reverse recovery test circuit & waveforms**

**Package Information**



SYMBOL	mm		
	MIN	NOM	MAX
A	0.70	0.80	0.90
A1	0.00	0.03	0.05
b	0.24	0.30	0.35
c	0.10	0.15	0.20
D	3.25	3.32	3.40
D1	3.05	3.15	3.25
D2	2.40	2.50	2.60
E	3.00	3.10	3.20
E1	1.35	1.45	1.55
e	0.65 BSC		
H	3.20	3.30	3.40
L	0.30	0.40	0.50
L1	0.10	0.15	0.20
L2	1.13 REF		

Version 1: PDFN3.3\*3.3-K package outline dimension

## Ordering Information

Package Type	Units/ Reel	Reels/ Inner Box	Units/ Inner Box	Inner Boxes/ Carton Box	Units/ Carton Box
PDFN3.3*3.3-K	5000	2	10000	6	60000

## Product Information

Product	Package	Pb Free	RoHS	Halogen Free
SFS06R10NF	PDFN3.3*3.3	yes	yes	yes

## Legal Disclaimer

The information given in this document shall in no event be regarded as a guarantee of conditions or characteristics. With respect to any examples or hints given herein, any typical values stated herein and/or any information regarding the application of the device, Oriental Semiconductor hereby disclaims any and all warranties and liabilities of any kind, including without limitation, warranties of non-infringement of intellectual property rights of any third party.

For further information on technology, delivery terms and conditions and prices, please contact the Oriental Semiconductor sales representatives ([www.orientalsemi.com](http://www.orientalsemi.com)).

© Oriental Semiconductor Co.,Ltd. All Rights Reserved 